

# WELLS Counter Point

Volume 2 Issue 1, February 1998

THE ELECTRONIC, DIAGNOSTIC AND DRIVEABILITY RESOURCE.

*Throttle Position Sensors Shouldn't Depress You:*

## TPS Knowledge is Power

**T**oday's vehicles have a variety of sensors to keep the engine-control computer informed about various operating conditions.



One of these is the Throttle Position Sensor (TPS), which tracks the opening and closing of the engine's throttle.

The throttle plate is a valve inside the carburetor or fuel injection throttle body that allows air and fuel (or air only in the case of multipoint fuel injection) to be pulled into the engine by intake vacuum when the gas pedal is depressed. The throttle opening determines the engine's power output, so monitoring the position of the throttle gives the computer information it needs to determine engine load. This information along with input from other sensors such as the manifold absolute pressure (MAP) sensors and temperature sensors, then is used to calculate the engine's fuel requirements, spark timing and other functions.

### How It Works

The TPS is a three-wire, variable resistor (potentiometer) that changes resistance as the throttle opens. The TPS is provided with a voltage reference signal from the computer (VRef), usually 5 volts. As the position of the throttle changes, the corresponding change in the TPS's internal resistance alters the voltage signal that returns

to the computer via signal wire. The third wire provides a ground connection. So what the computer sees is a variable voltage signal that changes in direct proportion to the throttle position.

Most TPS sensors provide just under one volt at idle with the throttle closed, and up to five volts at wide-open throttle.

The TPS is attached to the throttle shaft and may be located on the outside of the fuel injection throttle body or carburetor, or on some applications, inside the carburetor itself. On some applications, there may also be a separate "nose" switch to detect when the throttle is at idle, and/or a wide-open throttle switch.

### Drivability Symptoms

A faulty TPS can cause drivability problems such as hesitation, stalling, an erratic idle, ping (spark knock), no torque converter lockup, hard starting, an intermittent check engine light while driving, poor fuel economy, and generally poor engine performance.

*continued on page 2*

## Thanks For Your Support Of Counter Point

As we welcome you to the second issue of WELLS' Counter Point newsletter, we want to thank technicians throughout the country for your strong response to our debut issue last November.

We're very pleased that thousands of you have asked to be added to the subscription list for Counter Point. We've also included two reply cards in this issue, so that technicians who have not yet done so can subscribe.

After all, Counter Point's goal is to provide valuable technical information that will make the job of today's technician easier.

Remember, you must subscribe to continue receiving Counter Point, which is quarterly publication. The next issue is in May, so send in your card today.

Once again, we also welcome diagnostic questions from technicians. They'll be answered in our "Fine Tuning" section by Jim Bates, Technical Services Director for WELLS. If you'd like to submit a question, be sure to send you name, address and phone number along with it. If your question is published, you'll receive a free shirt from WELLS.

In this issue of Counter Point, you'll find an in-depth article about diagnosing problems with throttle position sensors, tips on distributor caps, plus a brief article on WELLS Professional Gold™ line.

We hope they'll all be helpful to you. As always, we welcome your comments.

Throttle Position Sensors Shouldn't Depress You:

# TPS Knowledge is Power

If the TPS is loose, it may produce an erratic signal as if the throttle were opening and closing, causing an unstable idle and intermittent hesitation.

This condition probably won't set a trouble code.

On older applications that have an adjustable TPS, the initial adjustment is very important. If not set correctly to specifications, it can have an adverse effect on the fuel mixture.

A shorted TPS will produce a signal that's the equivalent of a wide-open throttle all the time. This will make the fuel mixture run rich and usually set a trouble code that corresponds to a voltage signal that's too high.

If the TPS is open, the computer will think the throttle is closed all the time. The resulting fuel mixture will be too lean and a trouble code that corresponds to a low-voltage signal may be set.

Dead spots in the TPS (a common condition) may cause "flat spots" in engine performance only at certain throttle positions.

### Sensor Quick Check

Here's a quick check you can use to check for a faulty TPS: First, with the engine and ignition off, unplug the electrical connector and attach an ohmmeter between the center terminal and one of the outer two terminals on the TPS. (See figure A) Manually operate the TPS by s-l-o-w-l-y opening the throttle. Note the ohmmeter reading. It should increase or decrease smoothly as you exercise the sensor through its full range of travel.

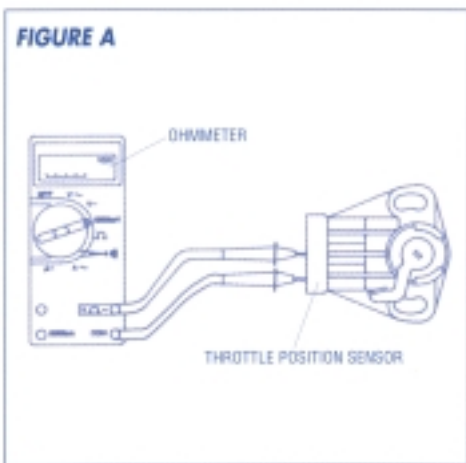

Next, connect the ohmmeter between the center terminal and the other outer terminal. Repeat the same test. The ohmmeter reading should again rise or decrease smoothly as you exercise the sensor.

# Fine Tuning



Fine Tuning questions are answered by Jim Bates, Technical Services Director. Please send your questions to: Jim Bates, C/O WELLS Manufacturing Corp., P.O. Box 70, Fond du Lac, WI 54936-0070 or e-mail him at technical@wellsmfgcorp.com. We'll send you a WELLS shirt if your question is published. So please include your shirt size with your question.

**Q: My customer's 1994 F150 pickup with a 5.0L V8 knocks badly when accelerating. Spark timing is okay. We've also cleaned carbon from the cylinders with a top cleaner. Is there any way to test the knock sensor?**

*Evan Ledbetter, Evan's Mobil, Greensboro, NC*

The knock sensor detects vibration frequencies that indicate detonation is occurring. This causes the computer to momentarily retard ignition timing. If the sensor is bad, this won't occur. The knock sensor can be tested on the vehicle with either a timing light or a variable reluctance sensor tester. To make the test, connect either the timing light to the number-one spark plug wire, or the variable reluctance sensor tester to the knock sensor's terminals.

Start the engine and allow it to warm up to normal operating temperature. Then while it is idling, use a small hammer or metal bar to tap lightly near the sensor. If you are using a timing light, you should see timing retard a few degrees momentarily after you simulate an engine knock. If you are using the variable reluctance sensor tester, the indicator light on the tester should flash brightly with each tap.

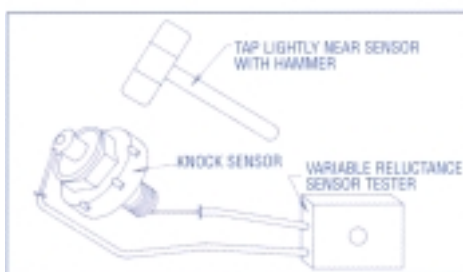

Another common cause of engine knock is loss of exhaust gas recirculation. Check the EGR valve and system for proper operation.

Other causes include a buildup of carbon on the pistons and inside the combustion chambers (which can be removed by using a chemical top cleaner product), engine overheating (check the operating temperature), exhaust restrictions (clogged converter) and low-octane gasoline.



**Q: A customer's '92 Dodge Caravan with a 3.0L engine failed an emissions test due to high CO. It is getting terrible fuel economy now. I've checked sensor data and it seems to be okay,**

**but the coolant temperature reads low. What could be the cause?**

*Allan Carvar, Village Car Care, Neperville, IL*

If you haven't checked the oxygen and coolant sensors already, you should do so. Failure of either can prevent the system from going into closed loop resulting in a fixed rich fuel condition and the problems you mentioned. If both sensors are okay, the problem might be caused by too low an operating temperature.

The engine may not be reaching its normal operating temperature because of a bad thermostat or a thermostat with too low a temperature rating for the application.

**Q: I have trouble keeping ignition coils in a customer's 1991 Ford Taurus. They seem to last only a few thousand miles and run real hot. I've checked the wiring, I've checked the grounds and I've made sure that I had the right replacement coil. Any idea why this is happening?**

*John Taylor, Chicago, IL*

The coil can fail if the current limiter in the ignition module is not working properly. Older cars used a ballast resistor to reduce the primary current to the coil, but on newer vehicles a current limiter is used within the module.

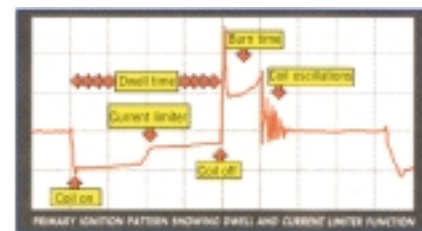

To tell if the current limiter is working properly, you have to look at the primary ignition pattern on an oscilloscope. Do this while the engine is idling (below 2,000 rpm). The section of the pattern you want to look at is the line between the point where the coil primary voltage is turned on and where it is shut off (the dwell period). About halfway along this line you should see a slight but sudden voltage rise if the current limiter is doing its job correctly. The time from the point where the coil is switched on (dwell starts) to the point where the primary current is limited should always exceed 3.00 milliseconds. If you don't see a jump in the line or the time is less than 3.00 mSec., either the module or coil is faulty.

# Fine Tuning

You should also rev the engine while observing the primary pattern to make sure swell lengthens (increases) as rpms go up, and shortens (decreases) as rpms go down.

**Q: My customer's 1989 Chevy Cavalier with a 2.0L engine has a burned-out ISC motor. The plunger is fully extended. Any reason why?**

*Fred Sparks, Fred's Garage, Spokane, WA*

This often results when there's an air or vacuum leak in the intake system. The ISC motor tries to compensate by reducing the amount of air allowed to bypass the throttle by fully extending the plunger to close the port. The constant load eventually burns out the motor. If you check the ISC counts, you'll probably find that they are at or near maximum. To prevent the same thing from happening to the replacement ISC motor, check the intake system and engine carefully for leaks. Common leak points include vacuum hoses, the PCV system, EGR system, intake manifold gaskets, and carburetor or throttle body base gasket.

## Throttle Position Sensors Shouldn't Depress You: TPS Knowledge is Power

Erratic readings or momentary infinity (open) readings indicate a defective sensor. (See figures B and C) Full continuity (zero ohms) in either position would indicate a shorted sensor.

### More Checks

A digital voltmeter or oscilloscope can also be used to observe the sensor's output voltage as well as to check the reference voltage from the computer. If the sensor is not receiving a full five volts, it can't generate the correct return signal.

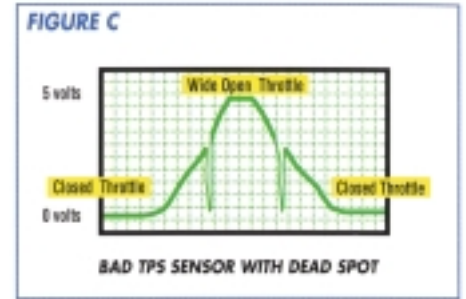
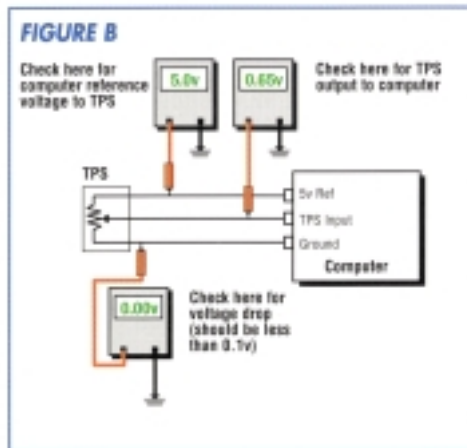

Check for the proper reference voltage between the TPS Vref wire terminal and ground with the ignition on. Less than five volts indicates a wiring or computer problem. Check for a good ground connection between the ground wire terminal and ground with the key on. The reading should be less than 0.1 volt.

Check for a voltage output signal between the signal wire and ground with the key on. This should vary from less than one volt at idle up to nearly five volts at wide-open throttle.

A scan tool can also be used on many applications to observe the TPS output voltage through the onboard computer system. But because the scan tool displays the sensor's output voltage as a digital reading, the display may not update quickly enough for you to detect a "skip" (dead spot) in the sensor's output as you open and close the throttle.

# Quality Points

## WELLS' Distributor Caps Take The Heat and Often Exceed OEM Specs

You can't tell much about the quality of a distributor cap by just looking at it, because most caps look pretty much the same on the outside. Even so, there can be significant differences in the materials used in the manufacture of distributor caps that affect the product's performance on a vehicle.

We found a competitor's cap that is made of materials that do not meet OEM specifications. The cap is for a popular GM application which requires a high temperature material such as "PBT" (polybutylene terephthalate). But this cap is made of "PP"



(polypropylene), which has a much lower melting temperature (350 degrees F vs. 482 degrees F for PBT). Though PP is often used for OEM distributor caps in other applications, it is not a suitable material for this particular application because it could fail under high-temperature operating conditions. It actually melted when subjected to the testing procedures that caps made by WELLS undergo, as the photo accompanying this article shown.

We also found that this cap was made in a mold designed for

THIS IS A COMPETITOR'S DISTRIBUTOR CAP. IT ACTUALLY MELTED UNDER THE SAME TESTING PROCEDURES THAT THE WELLS' (LOWER LEFT) CAP UNDERWENT.

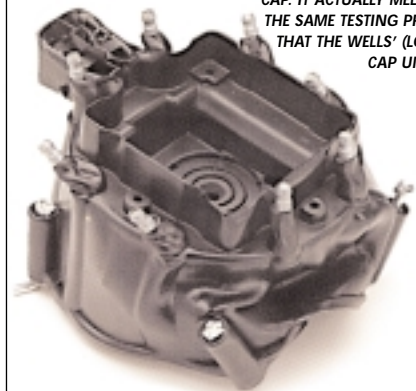

PBT, not PP. Consequently, because of differences in shrinkage rates, this cap had a slightly smaller inside diameter creating potential installation problems.

Our cap for this application is made out of an even better material that exceeds the OEM cap requirements: a blend of PBT and PET (polyethylene terephthalate). This material has an even higher melting point (500 degrees F) and also provides increased stiffness and resistance to warpage. That's the quality difference you'll find with WELLS products.



# WELLS

WELLS MANUFACTURING CORP.  
P.O. Box 70  
Fond du Lac, WI 54936-0070



## Hot off the Wire

### WELLS Professional Gold™ Program Is A Step Up

WELLS is offering its Professional Gold™ line for those who demand a premium distributor cap and rotor program.

Unlike regular caps and rotors, WELLS Professional Gold™ features solid brass inserts for maximum resistance to corrosion and electrical pitting to provide longer life. Specially coated brass rotor blades greatly reduce R.F.I.

The distinctive red color of the caps and rotors instantly differentiates WELLS Professional Gold™ line as the brand with high mineral content and glass reinforced molding compound for outstanding dielectric strength and higher resistance to dielectric breakdown.

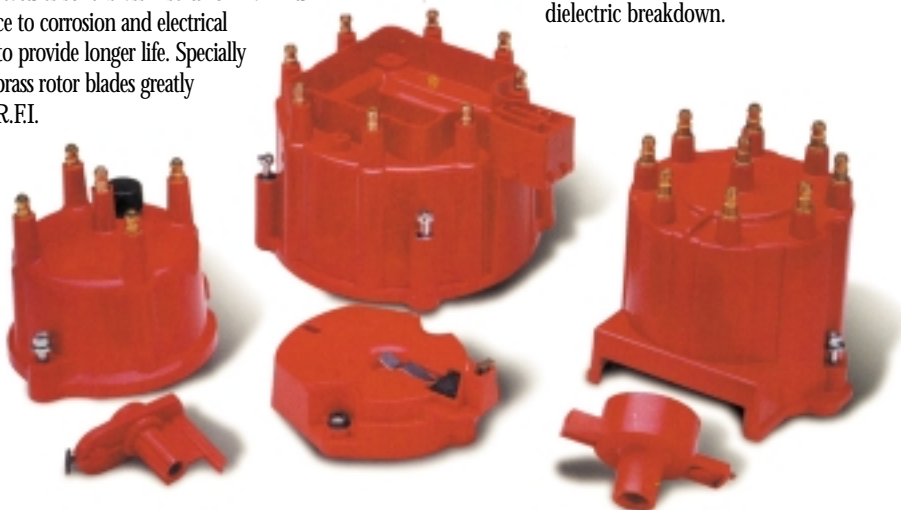

### Publisher's Information

WELLS' President .....William Allen  
Vice President Sales .....Gavin Spence  
Technical Services Director .....Jim Bates  
Newsletter Editor .....Ron Raposa

**Counter Point** is a quarterly publication of WELLS Manufacturing Corp., P.O. Box 70, Fond du Lac, WI 54936-0070. Letters and comments should be directed to: Ron Raposa, Counter Point Editor, 3602 Inland Empire Blvd, Suite C200, Ontario, CA 91764.

© COPYRIGHT 1998 WELLS MANUFACTURING CORP.  
All rights reserved. No reproduction in whole or part is permitted without the written consent of WELLS Manufacturing Corp. Requests should be faxed to Ron Raposa at (909) 941-0877.